

JVC

SERVICE MANUAL

COLOUR TELEVISION

AV-20N10
AV-20NTG2
AV-20NTG2_{I-A}

BASIC CHASSIS

CG

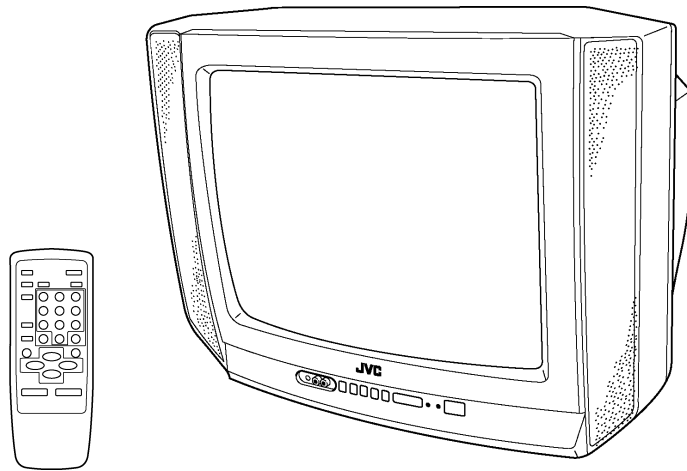

CONTENTS

■ SPECIFICATIONS	2
■ SAFETY PRECAUTIONS	3
■ FEATURES	4
■ FUNCTIONS	5
■ MAIN DIFFERENCE LIST	6
■ SPECIFIC SERVICE INSTRUCTIONS	7
■ SERVICE ADJUSTMENTS	14
■ PARTS LIST	31
★ OPERATING INSTRUCTIONS	
★ STANDARD CIRCUIT DIAGRAM	2-1

SPECIFICATIONS

ITEM		CONTENT	
		AV-20N10	AV-20NTG2 / AV-20NTG2-A
Dimensions(W × H × D)		619mm × 458mm × 488mm	←
Mass		19kg	←
TV RF System		B/G, I, D/K K1	←
Colour System	RF Mode	PAL / SECAM	←
	VIDEO Mode	PAL / SECAM / NTSC3.58 / NTSC4.43	←
Picture Tube		Visible size: 48cm measured diagonally	←
High Voltage		26.5kV ± 1.5kV(at zero beam current)	←
Receiving Frequency	VHF (VL)	46.25MHz~168.25MHz	←
	VHF (VH)	175.25MHz~463.25MHz	
	UHF	471.25MHz~863.25MHz	←
	CATV	Cable TVs of Mid (X-Z, S1-S10) Super (S11-S20) & Hyper (S21-S41) bands receivable	
Intermediate Frequency	VIF Carrier	38.0MHz	←
	SIF Carrier	32.5MHz(5.5MHz) 31.5MHz (6.5MHz) 32.0MHz (6.0MHz)	←
Colour Sub Carrier Frequency		PAL (4.43MHz), SECAM (4.40625MHz / 4.25MHz) NTSC (3.58MHz / 4.43MHz)	←
Power Input	Rated Voltage	AC220~240V, 50 / 60Hz	AC110~240V, 50 / 60Hz
Power Consumption		90W (Max) 60W(Avg)	←
Speaker		5cm × 12 cm, Oval type × 2	←
Audio Output		3W (monaural)	←
Aerial Input Terminal		75 Ω Unbalanced	←
Input	Video	1V(p-p), 75 Ω (Front / Rear)	←
	Audio	500mV(rms) (-4dBs), High impedance, RCA × 2 (Front / Rear)	←
Output	Video	1V(p-p), 75 Ω	←
	Audio	500mV(rms) (-4dBs), Low impedance,	←
Headphone jack		3.5mm mini jack	←
Remote Control Unit		RM-C364GY (Battery size : AA / R06 / UM-3 × 2)	←

Design and specifications are subject to change without notice.

SAFETY PRECAUTIONS

- The design of this product contains special hardware, many circuits and components specially for safety purposes. For continued protection, no changes should be made to the original design unless authorized in writing by the manufacturer. Replacement parts must be identical to those used in the original circuits. Service should be performed by qualified personnel only.
- Alterations of the design or circuitry of the products should not be made. Any design alterations or additions will void the manufacturer's warranty and will further relieve the manufacturer of responsibility for personal injury or property damage resulting therefrom.
- Many electrical and mechanical parts in the products have special safety-related characteristics. These characteristics are often not evident from visual inspection nor can the protection afforded by them necessarily be obtained by using replacement components rated for higher voltage, wattage, etc. Replacement parts which have these special safety characteristics are identified in the parts list of Service manual. **Electrical components having such features are identified by shading on the schematics and by (Δ) on the parts list in Service manual.** The use of a substitute replacement which does not have the same safety characteristics as the recommended replacement part shown in the parts list of Service manual may cause shock, fire, or other hazards.
- Don't short between the LIVE side ground and ISOLATED (NEUTRAL) side ground or EARTH side ground when repairing.**
Some model's power circuit is partly different in the GND. The difference of the GND is shown by the LIVE : (\perp) side GND, the ISOLATED(NEUTRAL) : (↯) side GND and EARTH : (\oplus) side GND. Don't short between the LIVE side GND and ISOLATED(NEUTRAL) side GND or EARTH side GND and never measure with a measuring apparatus (oscilloscope etc.) the LIVE side GND and ISOLATED(NEUTRAL) side GND or EARTH side GND at the same time.
If above note will not be kept, a fuse or any parts will be broken.
- If any repair has been made to the chassis, it is recommended that the B1 setting should be checked or adjusted (See ADJUSTMENT OF B1 POWER SUPPLY).
- The high voltage applied to the picture tube must conform with that specified in Service manual. Excessive high voltage can cause an increase in X-Ray emission, arcing and possible component damage, therefore operation under excessive high voltage conditions should be kept to a minimum, or should be prevented. If severe arcing occurs, remove the AC power immediately and determine the cause by visual inspection (incorrect installation, cracked or melted high voltage harness, poor soldering, etc.). To maintain the proper minimum level of soft X-Ray emission, components in the high voltage circuitry including the picture tube must be the exact replacements or alternatives approved by the manufacturer of the complete product.
- Do not check high voltage by drawing an arc. Use a high voltage meter or a high voltage probe with a VTVM. Discharge the picture tube before attempting meter connection, by connecting a clip lead to the ground frame and connecting the other end of the lead through a 10k Ω 2W resistor to the anode button.
- When service is required, observe the original lead dress. Extra precaution should be given to assure correct lead dress in the high voltage circuit area. Where a short circuit has occurred, those components that indicate evidence of overheating should be replaced. Always use the manufacturer's replacement components.

9. Isolation Check

(Safety for Electrical Shock Hazard)

After re-assembling the product, always perform an isolation check on the exposed metal parts of the cabinet (antenna terminals, video/audio input and output terminals, Control knobs, metal cabinet, screwheads, earphone jack, control shafts, etc.) to be sure the product is safe to operate without danger of electrical shock.

(1) Dielectric Strength Test

The isolation between the AC primary circuit and all metal parts exposed to the user, particularly any exposed metal part having a return path to the chassis should withstand a voltage of 3000V AC (r.m.s.) for a period of one second.

(. . . . Withstand a voltage of 1100V AC (r.m.s.) to an appliance rated up to 120V, and 3000V AC (r.m.s.) to an appliance rated 200V or more, for a period of one second.)

This method of test requires a test equipment not generally found in the service trade.

(2) Leakage Current Check

Plug the AC line cord directly into the AC outlet (do not use a line isolation transformer during this check.). Using a "Leakage Current Tester", measure the leakage current from each exposed metal part of the cabinet, particularly any exposed metal part having a return path to the chassis, to a known good earth ground (water pipe, etc.). Any leakage current must not exceed 0.5mA AC (r.m.s.).

However, in tropical area, this must not exceed 0.2mA AC (r.m.s.).

● Alternate Check Method

Plug the AC line cord directly into the AC outlet (do not use a line isolation transformer during this check.). Use an AC voltmeter having 1000 ohms per volt or more sensitivity in the following manner. Connect a 1500 Ω 10W resistor paralleled by a 0.15 μ F AC-type capacitor between an exposed metal part and a known good earth ground (water pipe, etc.). Measure the AC voltage across the resistor with the AC voltmeter. Move the resistor connection to each exposed metal part, particularly any exposed metal part having a return path to the chassis, and measure the AC voltage across the resistor. Now, reverse the plug in the AC outlet and repeat each measurement. Any voltage measured must not exceed 0.75V AC (r.m.s.). This corresponds to 0.5mA AC (r.m.s.).

However, in tropical area, this must not exceed 0.3V AC (r.m.s.). This corresponds to 0.2mA AC (r.m.s.).

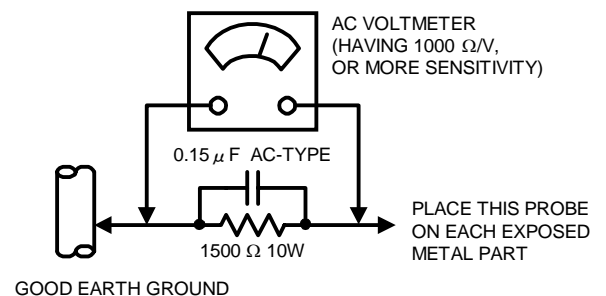

FEATURES

- New chassis design enables use of an interactive on-screen control.
- Wide range voltage (110V~240V) AC power input (AV-20NTG2 / AV-20NTG2-A).
- With AUDIO / VIDEO INPUT & OUTPUT terminal.
- MUTING button can reduce the audio level to zero instantly.
- Functional remote control to operate TV set (for channel select, volume control, power ON/OFF, etc.) from a distance.
- I²C bus control utilizes single chip ICs for IF, V/C, DEF. VSM PRESET, PRESET & TURBO TIMER.
- By means of AUTO PROGRAM, the TV stations can be selected automatically and the TV channels can also be rearranged automatically.
- Built-in AI ECO (ECONOMY, ECOLOGY) sensor.
In accordance with the brightness in a room, the brightness and / of contrast of the picture can be adjusted automatically to make the optimum picture which is easy on the eye.
- Built-in ON TIMER, RETURN + & CHILD LOCK.

SYSTEM BLOCK DIAGRAM

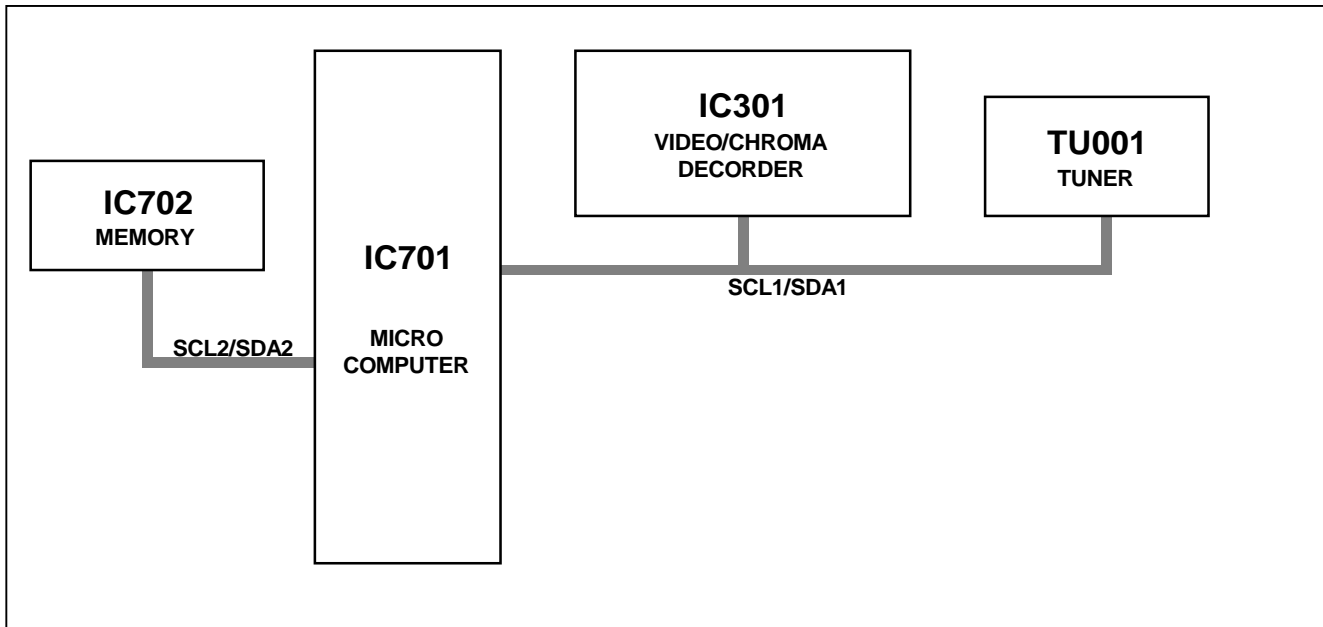

FUNCTIONS

FRONT PANEL

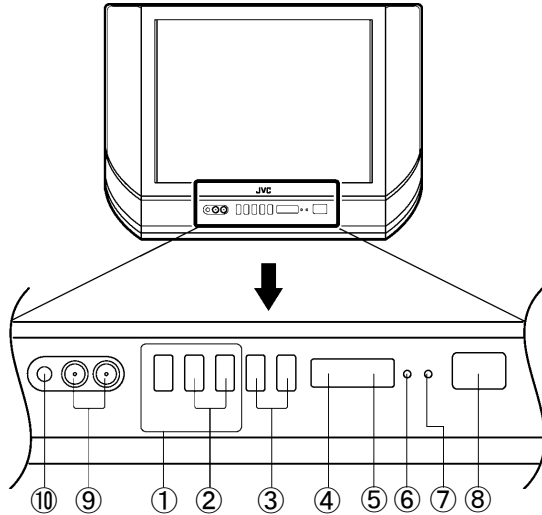

- ① MENU buttons
- ② CHANNEL -/+ buttons
- ③ VOLUME -/+ buttons
- ④ ECO sensor
- ⑤ REMOTE CONTROL sensor
- ⑥ ON TIMER lamp
- ⑦ POWER lamp
- ⑧ MAIN POWER button
- ⑨ A/V INPUT terminal
- ⑩ HEADPHONE jack

REAR TERMINAL

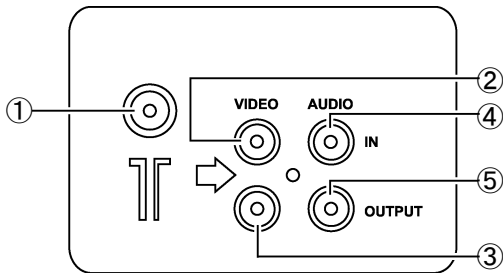

- ① ANT Terminal
- ② VIDEO INPUT Terminal
- ③ VIDEO OUTPUT Terminal
- ④ AUDIO INPUT Terminal
- ⑤ AUDIO OUT PUT Terminal

REMOTE CONTROL UNIT(RM-C364GY)

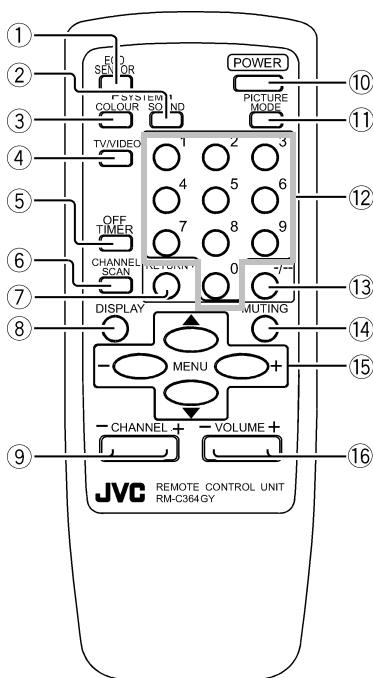

- ① ECO SENSOR key
- ② SOUND SYSTEM key
- ③ COLOUR SYSTEM key
- ④ TV/VIDEO key
- ⑤ OFF TIMER key
- ⑥ CHANNEL SCAN key
- ⑦ RETURN+key
- ⑧ DISPLAY key
- ⑨ CHANNEL -/+ key
- ⑩ POWER key
- ⑪ PICTURE MODE key
- ⑫ Number (CH.) key
- ⑬ -/- -key
- ⑭ MUTING key
- ⑮ MENU key
 - MENU ▲/▼ key
 - MENU -/+ key
- ⑯ VOLUME -/+ key

MAIN DIFFERENCE LIST

△	Model Name Part Name	AV-20N10	AV-20NTG2	AV-20NTG2/-A
	MAIN PWB	SCG-1287A-H2	SCG-1288A-H2	←
△	FRONT CABINET	LC10438-022A-H	LC10438-023A-H	←
△	POWER CORD	QMPR340-165-K2	←	QMPR010-200-E2 or QMPR010-200-K2
△	RATING LABEL	GG20014-002A-H	LC20377-001B-H	LC20413-002B-H
	PACKING CASE	GG10056-055A-H	GG10056-056A-H	←
△	INST. BOOK	LCT1039-001A-H	LCT0994-001B-H	←
△	DIGEST MANUAL	LCT1034-001A-H	LCT0993-001B-H	←
	CONVERSION PLUG	—————	—————	QAM0055-001

SPECIFIC SERVICE INSTRUCTIONS

DISASSEMBLY PROCEDURE

REMOVING THE REAR COVER

1. Unplug the power plug.
2. As shown in figure, remove the **6** screws marked **(A)** and a screw marked **(B)** .
3. Withdraw the rear cover toward you.

REMOVING THE MAIN PW BOARD

- After removing the rear cover.
1. Slightly raise the both sides of the MAIN PW Board by hand.
 2. Withdraw the MAIN PW Board backward.
(If necessary, take off the wire clamp, connectors etc.)

REMOVING THE SPEAKER

- After removing the rear cover.
1. As shown in figure, remove the **2** screws marked **(C)** .
 2. Follow the same steps when removing the other hand speaker.

CHECKING THE MAIN PW BOARD

1. To check the back side of the PW Board.
 - 1) Pull out the MAIN PW Board. (Refer to REMOVING THE MAIN PW Board)
 - 2) Erect the PW Board vertically so that you can easily check the back side of the PW Board.

[CAUTION]

- When erecting the PW Board, be careful so that there will be no contacting with other PW Board.
- Before turning on power, make sure that the CRT earth wire and other connector are properly connected.

WIRE CLAMPING AND CABLE TYING

1. Be sure to clamp the wire.
2. Never remove the cable tie used for tying the wires together.
Should it be inadvertently removed, be sure to tie the wires with a new cable tie.

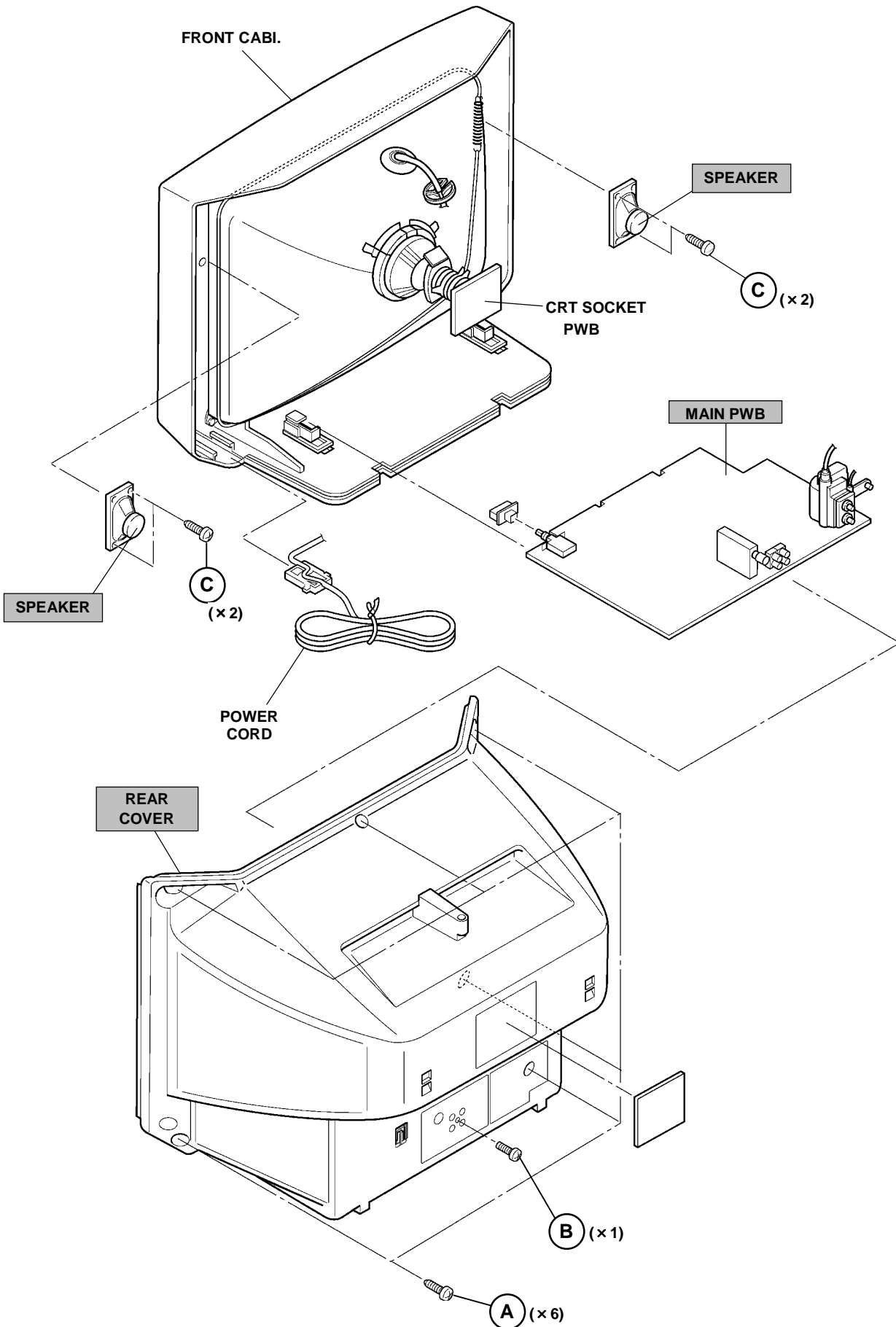

REPLACEMENT OF MEMORY ICs

1. MEMORY ICs

This model uses memory ICs. This memory IC data are for proper operation of the video and deflection circuits.
When replacing memory ICs, be sure to use ICs written with the initial values of data.

2. PROCEDURE FOR REPLACING MEMORY ICs

(1) Power off

Switch the power off and disconnect the power plug from the wall outlet.

(2) Replace ICs

Be sure to use memory ICs written with the initial data values.

(3) Power on

Connect the power plug into the wall outlet and switch the power on.

(4) Check and set SYSTEM CONSTANT SET

- It must not adjust without adjustment signals.

- 1) Press the **DISPLAY** key and the **PICTURE MODE** key of the REMOTE CONTROL UNIT simultaneously.
- 2) The SERVICE MENU screen of Fig. 1 will be displayed.
- 3) While the SERVICE MENU is displayed, again press the **DISPLAY** key and **PICTURE MODE** key simultaneously, and the SYSTEM CONSTANT SET screen of Fig. 2 will be displayed.
- 1) Check the setting values of the SYSTEM CONSTANT SET of Table 1 If the value is different, select the setting item with the **MENU** ∇/\blacktriangle key, and set the correct value with the **MENU** - / + key.
- 5) Press the **DISPLAY** key twice, and return to the normal screen.

(5) Receive channel of setting

Refer to the **OPERATING INSTRUCTIONS** and set the receive channels (channels preset) as described

(6) User Setting

Check the user setting value of Table 2, and if setting value is different, set the correct value.

For setting, refer to the **OPERATING INSTRUCTIONS**.

(7) Setting of SERVICE MENU

Verify the setting items of the SERVICE MENU, and reset where necessary.

For setting, refer to the **SERVICE ADJUSTMENTS**.



Fig.1

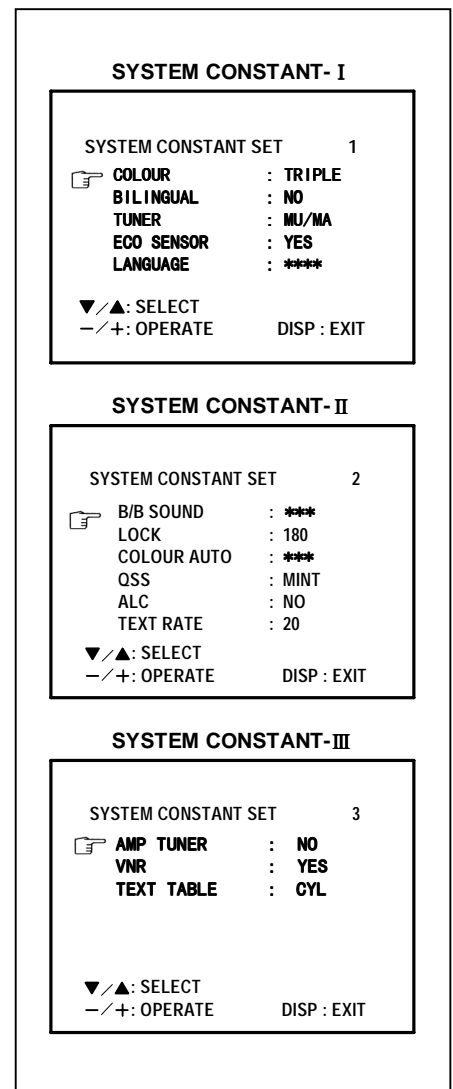
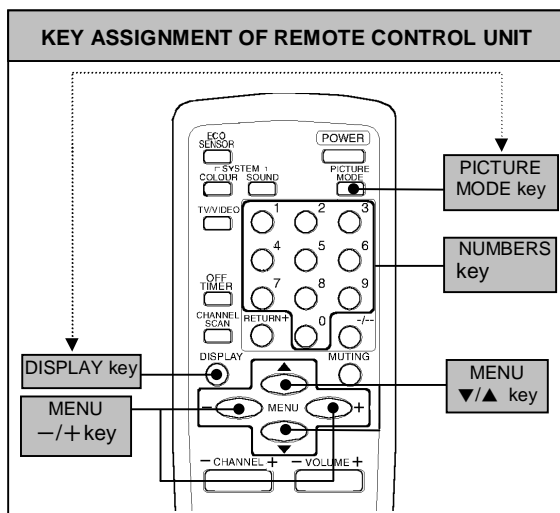

Fig.2



SETTING OF SYSTEM CONSTANT SET

Setting item	Setting contents	Setting value		
		AV-20N10	AV-20NTG2	AV-20NTG2/A
COLOUR	▶ MULTI. → TRIPLE → PAL ◀	TRIPLE	←	←
BILINGUAL	▶ YES → NO ◀	NO	←	←
TUNER	▶ MU → MA ◀	MA	←	←
ECO SENSOR	▶ YES → NO ◀	YES	←	←
LANGUAGE	▶ E/A/R/F → E/R/C → E/R/U → E/F ◀	E/R/C	E/A/R/F	←
B/B SOUND	▶ ON → OFF ◀	OFF	←	ON
LOCK	YES ↔ 10 ↔ 20 ↔ ~ ↔ 230 250 ↔ 240 ◀	180	←	←
COLOUR AUTO	▶ YES → NO ◀	NO	←	YES
QSS	▶ MINT → MQSS ◀	MINT	←	←
ALC	▶ YES → NO ◀	NO	←	←
TEXT RATE	10 ↔ 20 ↔ 40 ↔ 80	20	←	←
AMP TUNER	▶ YES → NO ◀	NO	←	←
VNR	▶ YES → NO ◀	YES	←	←
TEXT TABLE	▶ ARA → CYL ◀	CYL	←	←

Table 1

USER SETTING VALUES

Setting item	Setting value	Setting item	Setting value
MAIN POWER SW	OFF	PICTURE MODE (VSM)	BRIGHT
SUB POWER	ON	LANGUAGE	ENGLISH (ENG)
CHANNEL POSITION	1 POSITION	CHANNEL PRESET	Refer to OPERATING INSTRUCTION
VOLUME	About 10	ECO SENSOR	OFF
TV/VIDEO	TV	VNR	OFF
ON SCREEN DISPLAY	POSITION INDICATION	AUTO SHUTOFF	OFF
COLOUR SYSTEM	PAL	ON TIMER	PR1 0:00
SOUND SYSTEM	B / G	BLUE BACK	OFF
OFF TIMER	OFF (shown : 00)	CHILD LOCK	OFF

Table 2

INITIAL SETTING VALUE OF SERVICE MENU

1. Adjustment of the SERVICE MENU is made on the basis of the initial setting values ; however, the new setting values which set the screen in its optimum condition may differ from the initial setting.
2. Do not change the initial Setting Values of the Setting (Adjustment) items not listed In "ADJUSTMENT".

2. V/C

Colour system Setting item		Variable range	Initial setting value			
			PAL	SECAM	NTSC 3.58	NTSC 4.43
1. CUT OFF	RED	-128~+127	-50	←	←	←
	GREEN					
	BLUE					
2. DRIVE	RED	-128~+127	+ 0	←	←	←
	BLUE					
3. BRIGHT		-127~+127	+ 0	←	←	←
4. CONT.		-63~+63	+ 0	←	←	←
5. COLOUR		-63~+63	+ 0	←	←	←
6. TINT	TV	-63~+63	—	—	+ 0	+ 0
	VIDEO		—	—	+ 0	- 2
7. SECAM BL ADJ.		-31~+31	+ 0	←	←	←
8. SHARP (Do Not Adj.)	TV	-32~+31	- 8(Fixed)	←	←	←
	VIDEO		+15(Fixed)			

3. DEFLECTION

Setting item	Variable range	Initial setting value	
		fv : 50Hz MODE	fv : 60Hz MODE
1. VER. POSITION	-04 ~ +03	- 1	- 3
2. HOR. POSITION	-16 ~ +15	+ 3	+ 3
3. VER. HEIGHT	-64 ~ +63	-35	+ 1
4. VER. LINEARITY	-32 ~ +31	+15	- 1
5. VER. SCURVE	-32 ~ +31	-32	+ 0
6. HOR. VCO ADJUST (Do Not Adj.)	-63 ~ +62	+ 0	+ 0

4. VSM PRESET

VSM Setting item	VSM preset mode	BRIGHT	STANDARD	SOFT
TINT SETTING VALUE		+15	←	←
COLOUR SETTING VALUE		+15	←	←
BRIGHT SETTING VALUE		+15	←	←
CONT. SETTING VALUE		+30	+15	+8
SHARP SETTING VALUE		+15	←	+12

5. PRESET

The items in the following table, it is no requirement for adjustment.
If values had changed by the miss operation, set the initial setting values in the following table.

Colour System **Do Not Adjust**

Setting item		Initial setting value (Fixed value)			
		PAL	SECAM	NTSC 3.58	NTSC 4.43
1. C TRAP FIX		1	1	1	1
2. SHARP PEAK		0	0	0	0
3. ABL		1	1	1	1
4. GAMMA		0	0	0	0
5. Y. DELAY TIME	TV	0	2	2	3
	VIDEO	0	2	0	2
6. BLACK EXP START		+3	+3	+3	+3
7. C-BPF	TV	1	1	0	0
	VIDEO	1	1	1	1
8. CW / SCP		0	0	0	0
9. VIF DET LEVEL		0	0	0	0
11. IF AGC MIN		0	0	0	0
12. VIF AGC		0	0	0	0
13. VIF PMOD		0	0	0	0
19. VNR		15	15	15	15
20. RGB LIM		1	1	1	1
21. RGB LIMIT LEVEL		2	2	2	2
23. TEXT H. POSITION		-3	-3	-3	-3
24. READ DATA		_____	_____	_____	_____

Sound System **Do Not Adjust**

Setting item	B/G	I	D/K	M
10. SIF DET LEVEL	+0	+0	+0	+0
14. SIF BPF BW ADJUST	0 (-)	0 (-)	0 (-)	0 (-)
15. SIF TRAP FO ADJUST	0 (-)	0 (-)	0 (-)	0 (-)
16. SIF TRAP FO ADJUST 2	0 (-)	0 (-)	0 (-)	0 (-)
17. SIF -TRAP	0	0	0	0
18. SIF -BPF	0	0	0	1
22. SIF SW	1	1	1	0

REPLACEMENT OF IC301 (IF V/C DECODER)

- For the IC301(IF V/C DECODER) of this model, all data are written in the micro-computer. So, write the data in the micro-computer in accordance with the following procedures before starting adjustment.

REPLACING PROCEDURES

- (1) Turn the POWER OFF.
- (2) Replace the IC301 with a new one.
- (3) While pressing MENU button and VOL+ button ON the FRONT CABINET simultaneously, turn the POWER ON. When the POWER is turned ON, the data is written in the micro-computer immediately.

LOCATIONS OF FRONT PANEL BUTTONS AND LAMPS

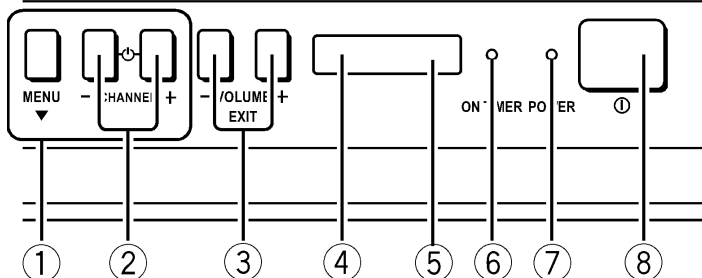
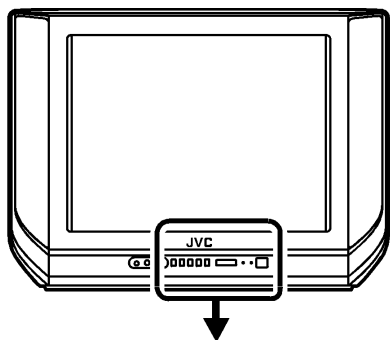

- ① MENU buttons

- ② CHANNEL -/+ buttons
(MENU -/+ buttons)

- ③ VOLUME -/+ buttons
(MENU -/+ buttons)

- ④ ECO sensor

- ⑤ REMOTE CONTROL sensor

- ⑥ ON TIMER lamp

- ⑦ POWER lamp

- ⑧ MAIN POWER button

SERVICE ADJUSTMENTS

BEFORE STARTING SERVICE ADJUSTMENT

1. There are 2 way of adjusting this TV: One is with the REMOTE CONTROL UNIT and the other is the conventional method using adjustment parts and components.
2. The adjustment with the REMOTE CONTROL UNIT is made on the basis of the initial setting values. The setting values which adjust the screen to its optimum condition may differ from the initial setting values.
3. Make sure that connection is correctly made to AC power source.
4. Turn on the power of the set and equipment before use, and start the adjustment procedures after waiting at least 30 minutes.
5. Unless otherwise specified, prepare the most suitable reception or input signal for adjustment.
6. Never touch any adjustment parts, which are not specified in the list for this adjustment VRs, transforms, condensers, etc.
7. Preparation for adjustment
Unless otherwise specified in the adjustment instructions, preset the following functions with the REMOTE CONTROL UNIT.

User mode position

PICTURE MODE (VSM)	BRIGHT
VNR	OFF
TINT / COLOUR / BRIGHT CONT. / SHARP	CENTER
BLUE BACK	OFF
OFF TIMER	OFF
ECO SENSOR	OFF
AUTO SHUT OFF	OFF

MEASURING INSTRUMENT AND FIXTURES

1. DC voltmeter (or digital voltmeter)
2. Oscilloscope
3. Signal generator (Pattern generator) [PAL / SECAM / NTSC]
4. Remote control unit

ADJUSTMENT ITEMS

Adjustment item	Adjustment item
B1 POWER SUPPLY	DEFLECTION circuit adjustment
FOCUS adjustment	VSM PRESET setting
IF circuit adjustment	PURITY / CONVERGENCE adjustment
V/C (Video / Chroma) circuit adjustment	

BASIC OPERATION OF SERVICE MENU

● The adjustment using SERVICE MENU

The following adjustment items use the SERVICE MENU in the series of the adjustment. The adjustments are made on the basis of the initial setting values. The adjustment values which adjust the screen to the optimum condition can be different from the initial setting values. With the SERVICE MENU, various settings can be made, and they are broadly classified in the following items of settings.

- 1.IF..... Adjustment of the IF circuits.
- 2.V/C Adjustment of the VIDEO/CHROMA circuit.
- 3.DEF Adjustment of the DEFLECTION circuit.
- 4.VSM PRESET..... Adjustment of the initial setting values of VSM condition as STANDARD, SOFT and BRIGHT.
(VSM : Video Status Memory)
- 5.PRESET Adjustment of the RF circuit **[Do not adjust]**.
- 6.TURBO TIMER..... For quick setting the TIMER count value, adjustable not only by minuets but also by second.
[Should be OFF].

● Key operation of the SERVICE MENU

[Enter to SERVICE MENU]

Press the **DISPLAY** key and the **PICTURE MODE** key of the REMOTE CONTROL UNIT simultaneously. Then enter the SERVICE MENU mode as shown in Fig.1.

[Exit from SERVICE MENU]

When complete the adjustment work, press the **DISPLAY** key to return to the SERVICE MENU.

And then press the **DISPLAY** key again, return to the normal screen.

[Select from SERVICE MENU]

In SERVICE MENU, press the number (1~6) key of the remote control unit, to select any of the adjustment items.

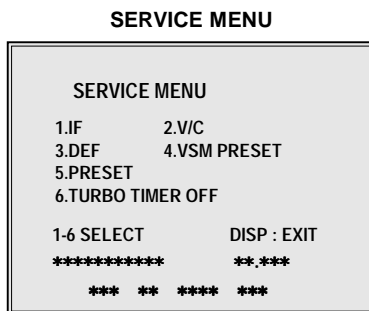
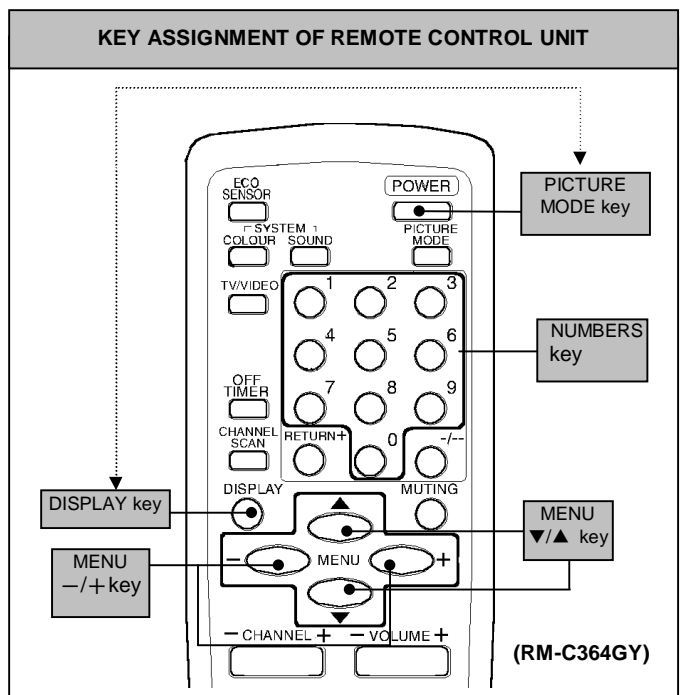

Fig.1



[Method of setting]

1. IF

[1. VCO]

- ① 1 Key..... Select **1.IF**.
- ② 1 Key..... Select **1.VCO**
- ③ The VCO (CW) screen will be displayed a allow mark when the AFC voltage is at a certain level.
- ④ DISPLAY Key When this is pressed twice, you will return to the **SERVICE MENU**.

[2. DELAY POINT]

- ① 1 Key..... Select **1.IF**.
- ② 2 Key..... Select **2.DELAY POINT**.
- ③ MENU +/- Set (adjust) the setting values of the setting items.
- ④ DISPLAY Key When this is pressed twice, you will return to the **SERVICE MENU**.

2.V/C, 3.DEF and 4.VSM PRESET

- ① 2-4Key Select one from **2. V/C, 3. DEF** and **4. VSM PRESET**.
- ② MENU ▼/▲ Key Select setting items.
- ③ MENU +/- Adjust the values of the items.
- ④ DISPLAY Key When this is pressed, return to the **SERVICE MENU**.

6.TURBO TIMER

- ① By pressing the 6 key, you can change the ON or OFF (**should be OFF**).
(Should be OFF)
 - * If it is ON, the timer in TIMER mode changes from 1 minute into 1 sec temporarily.
(It is easier to checks the Operation of TIMER)
If you turn the TV power off, this setting becomes OFF automatically.

SERVICE MENU FLOW CHART

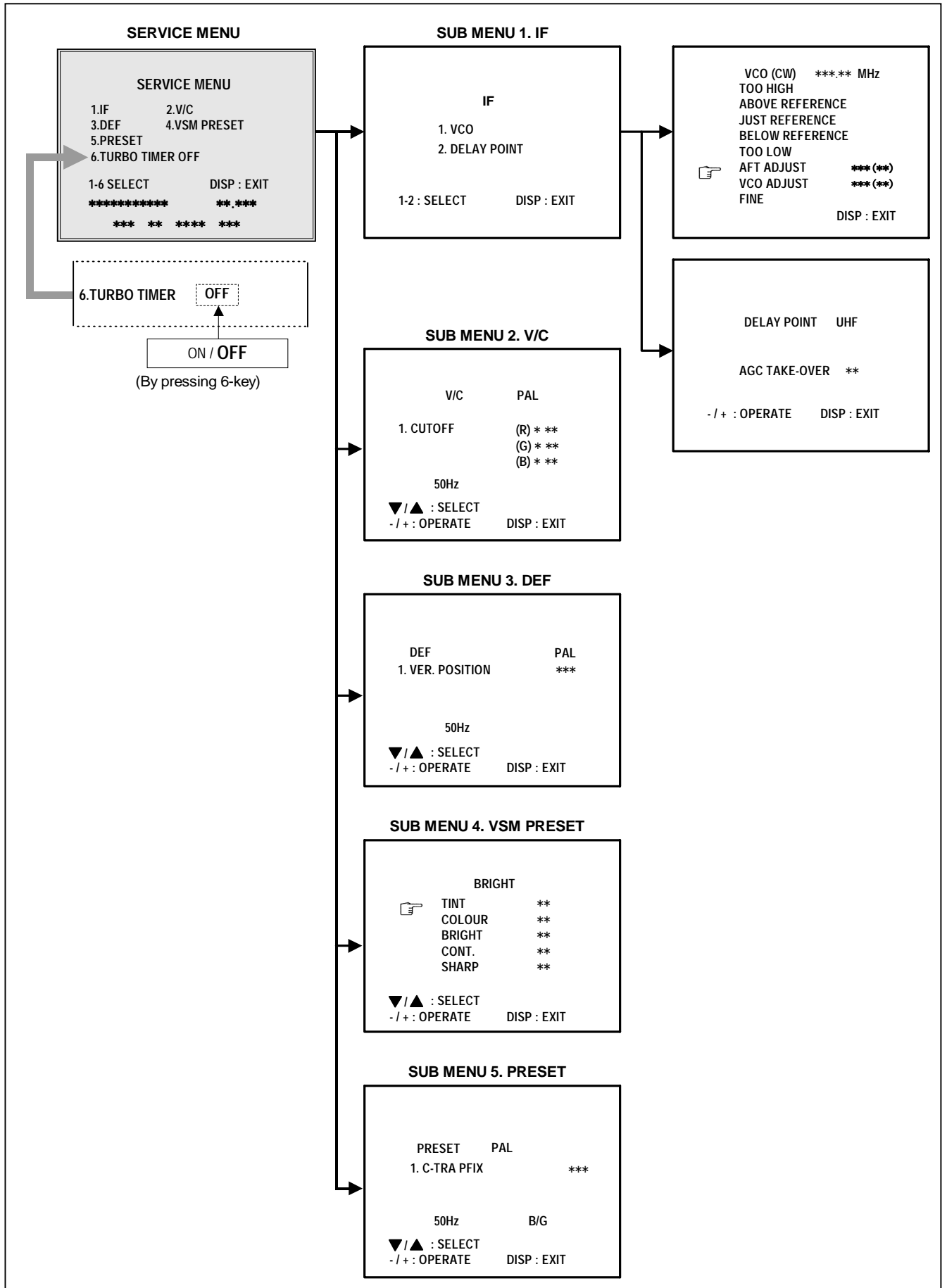

ADJUSTMENT LOCATIONS

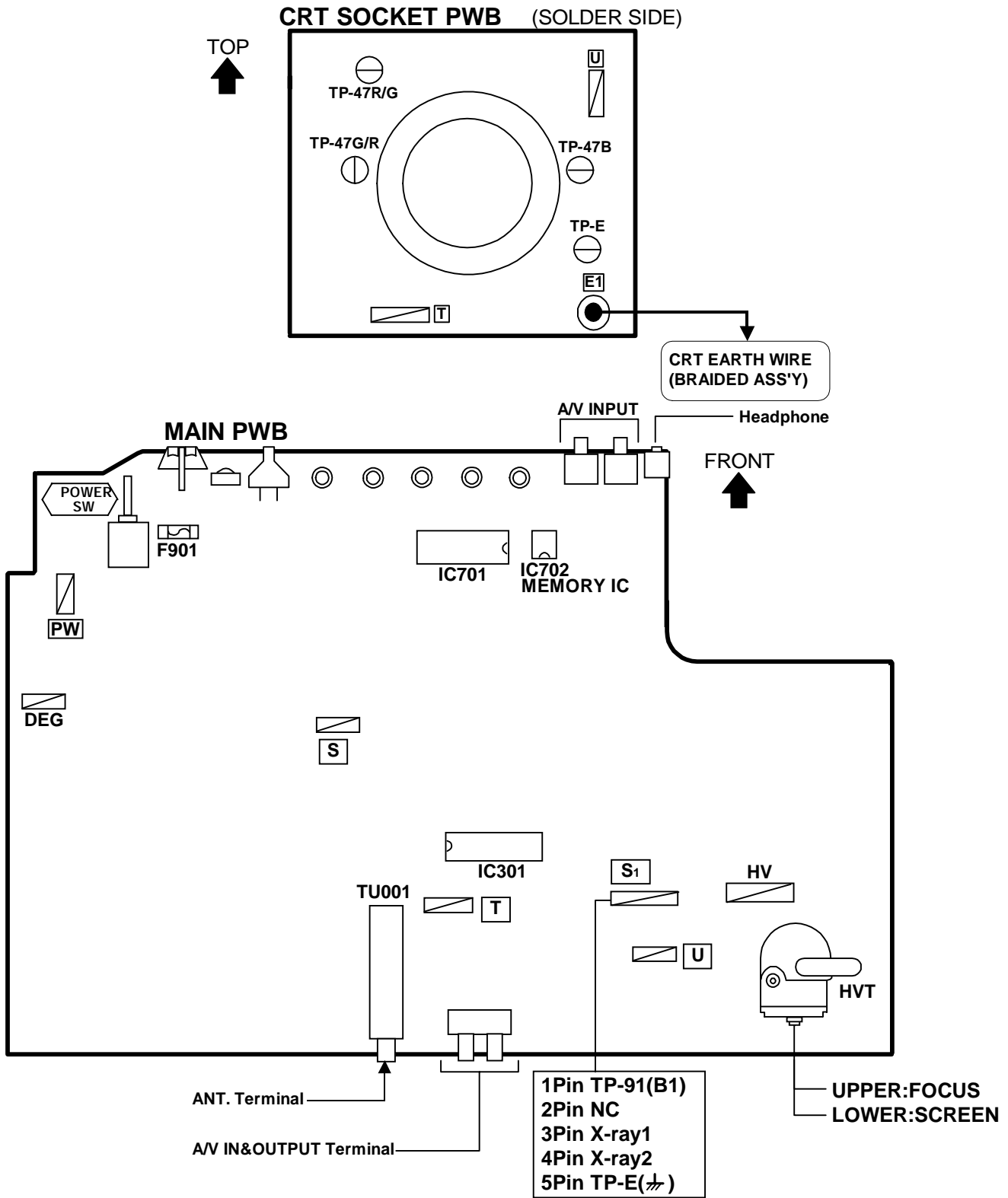

ADJUSTMENTS

B1 POWER SUPPLY

Item	Measuring instrument	Test point	Adjustment part	Description
Check of B1 Power Supply	Signal generator DC Volt-meter	TP-91 (B1) TP-E (↵)		1. Input a whole black signal. 2. Connect a DC voltmeter to TP-91(B1) and TP-E (↵). 3. Make sure that the voltage is $DC114.5 \pm 1.5V$.

FOCUS ADJUSTMENT

Item	Measuring instrument	Test point	Adjustment part	Description
Adjustment of FOCUS	Signal generator		FOCUS VR [In HVT]	1. Input a cross-hatch signal. 2. While watching the screen, adjust the FOCUS VR to make the vertical and horizontal lines as fine and sharp as possible. 3. Make sure that when the screen is darkened, the lines remain in good focus.

IF CIRCUIT ADJUSTMENT

Item	Measuring instrument	Test point	Adjustment part	Description
Adjustment of VCO(CW)	Signal generator Remote control unit		1. VCO	<p>● Please use signal generator which is correct proof about the sending frequency.</p> <p>1. Input the PAL full colour bar (210.25MHz) signal. 2. Select 1.IF from the SERVICE MENU. 3. Press 1 key and select 1.VCO. 4. Select VCO ADJUST with MENU ▲/▼ key. 5. Press MENU -/+ key until the colour of the characters TOO HIGH changes blue to yellow. Then gradually press the MENU -/+ key until the TOO LOW changes yellow. At this time, confirm that the value of VCO ADJUST is near +00. 6. Select AFT ADJUST with MENU ▲/▼ key. 7. Press MENU -/+ key until the characters JUST REFERENCE changes blue to yellow. 8. Press the DISPLAY key three times to return to normal screen.</p>

The diagram shows a menu screen for VCO adjustment. The menu items are: VCO (CW) ****.*** MHz, TOO HIGH, ABOVE REFERENCE, JUST REFERENCE, BELOW REFERENCE, TOO LOW, AFT ADJUST ****(##), VCO ADJUST ****(##), FINE, and DISP: EXIT. A yellow arrow points from the 'JUST REFERENCE' line to the 'YELLOW' label. A black arrow points from the 'FINE' line to the 'Do not adjust' label. Below the menu is a graph showing a trapezoidal frequency response curve. The y-axis represents signal level with markers for TOO HIGH, ABOVE REFERENCE, JUST REFERENCE, BELOW REFERENCE, and TOO LOW. The x-axis represents frequency. A vertical dashed line indicates the 'ADJUSTMENT POINT' at the 'JUST REFERENCE' level. A horizontal double-headed arrow above the peak of the curve is labeled 'ADJUSTMENT AT THIS POINT IS USELESS'.

Item	Measuring instrument	Test point	Adjustment part	Description												
Adjustment of DELAY POINT (AGC)	Signal generator Remote control unit		DELAY POINT (AGC TAKE-OVER)	<ol style="list-style-type: none"> 1. Input a black and white signal (colour off). 2. Select 1. IF from the SERVICE MENU. 3. Select 2. DELAY POINT by pressing the 2 key on the remote control unit. 4. Set the setting values of the setting items as shown bellow table. 5. Then adjust the MENU - or + key until video noise disappears. 6. Turn to other channels and make sure that there are no irregularities. 												
<table border="1" style="width: 100%; border-collapse: collapse;"> <tr> <td style="padding: 5px;">DELAY POINT UHF</td> </tr> <tr> <td style="padding: 5px;">AGC TAKE-OVER **</td> </tr> <tr> <td style="padding: 5px;">- / + : OPERATE DISP : EXIT</td> </tr> </table>					DELAY POINT UHF	AGC TAKE-OVER **	- / + : OPERATE DISP : EXIT									
DELAY POINT UHF																
AGC TAKE-OVER **																
- / + : OPERATE DISP : EXIT																
<table border="1" style="width: 100%; border-collapse: collapse;"> <thead> <tr> <th colspan="2" style="padding: 5px;">Setting Item</th> <th style="padding: 5px;">Variable range</th> <th style="padding: 5px;">Initial setting value</th> </tr> </thead> <tbody> <tr> <td rowspan="3" style="padding: 5px; vertical-align: middle;">DELAY POINT (AGC TAKE OVER)</td> <td style="padding: 5px;">NTSC 3.58</td> <td rowspan="3" style="padding: 5px; vertical-align: middle;">0~127</td> <td style="padding: 5px; text-align: center;">MA. (QAU0191-002)</td> </tr> <tr> <td style="padding: 5px;"></td> <td style="padding: 5px; text-align: center;">41</td> </tr> <tr> <td style="padding: 5px;">OTHER</td> <td style="padding: 5px; text-align: center;">41</td> </tr> </tbody> </table>					Setting Item		Variable range	Initial setting value	DELAY POINT (AGC TAKE OVER)	NTSC 3.58	0~127	MA. (QAU0191-002)		41	OTHER	41
Setting Item		Variable range	Initial setting value													
DELAY POINT (AGC TAKE OVER)	NTSC 3.58	0~127	MA. (QAU0191-002)													
			41													
	OTHER		41													

VIDEO / CHROMA CIRCUIT ADJUSTMENT

The setting (adjustment) using the REMOTE CONTROL UNIT is made on the basis of the initial setting values.
The setting values which adjust the screen to the optimum condition can be different from the initial setting values.
Do not change the initial setting values of the setting items not listed in "ADJUSTMENT".

Item	Measuring instrument	Test point	Adjustment part	Description
Adjustment of WHITE BALANCE (Low light)	Signal generator Remote control unit		1. CUT OFF (R) CUT OFF (G) CUT OFF (B) SCREEN VR [IN HVT]	1. Input a black and white signal (colour off). 2. Select 2. V/C from the SERVICE MENU, then select 1. CUT OFF (R), (G) and (B) . 3. Set each value to initial setting value with 4~9 keys of the remote control unit. 4. Press the 1 key of the remote control unit to show the single horizontal line on screen. 5. Turn the SCREEN VR fully counter-clockwise, then slowly turn it clockwise to where one of a red, blue or green colour is faintly visible. 6. Use keys 4~9 of the remote control unit and adjust the other 2 colours which except the appeared colour to where the single horizontal line appears white. 7. Turn the SCREEN VR to where the single horizontal line glows faintly. 8. Press the 2 key to turn off the single horizontal line. 9. Press the DISPLAY key twice to return to the normal screen.
				<div style="border: 1px solid black; padding: 5px; margin-bottom: 10px;"> <p style="text-align: center;">V/C AUTO</p> <p style="text-align: center;">1. CUTOFF (R) * ** (G) * ** (B) * **</p> <p style="text-align: center;">50Hz</p> <p style="text-align: center;">▼/▲ : SELECT -/+ : OPERATE DISP : EXIT</p> </div> <div style="border: 1px solid black; padding: 5px;"> <p style="text-align: center;">KEY ASSIGNMENT OF REMOTE CONTROL UNIT</p> </div>
Adjustment of WHITE BALANCE (High light)	Signal generator Remote control unit		2. DRIVE (R) DRIVE (B)	1. Input a black and white signal (colour off). 2. Select 2. V/C from the SERVICE MENU. 3. Select 2. DRIVE (R) / (B) with MENU ▼/▲ key, and set each value to initial setting value with 4 and 7 or 6 and 9 keys of the remote control unit. 4. Use the keys 4 and 7 or 6 and 9 to produce a white screen 5. Press the DISPLAY key twice to return to the normal screen.
				<div style="border: 1px solid black; padding: 5px; margin-bottom: 10px;"> <p style="text-align: center;">V/C AUTO</p> <p style="text-align: center;">2. DRIVE (R) * ** (B) * **</p> <p style="text-align: center;">50Hz</p> <p style="text-align: center;">▼/▲ : SELECT -/+ : OPERATE DISP : EXIT</p> </div>

Item	Measuring instrument	Test point	Adjustment part	Description
Adjustment of SUB BRIGHT	Remote control unit		3. BRIGHT	<ol style="list-style-type: none"> 1. Receive any broadcast. 2. Select 2. V/C from SERVICE MENU. 3. Select 3. BRIGHT with the MENU ▼/▲key. 4. Set the initial setting value with the MENU - or + key. 5. If the brightness is not the best with the initial set value, make fine adjustment until you get the best brightness.
Adjustment of SUB CONT.	Remote control unit		4. CONT.	<ol style="list-style-type: none"> 1. Receive any broadcast. 2. Select 2. V/C from SERVICE MENU. 3. Select 4. CONT. with the MENU ▼/▲key. 4. Set the initial setting value with the MENU - or + key. 5. If the contrast is not the best with the initial set value, make fine adjustment until you get the best contrast.
Adjustment of SUB COLOUR I	Remote control unit		5. COLOUR	[Method of adjustment without measuring instrument]
			PAL COLOUR	<ol style="list-style-type: none"> 1. Receive a PAL broadcast. 2. Select 2. V/C from the SERVICE MENU. 3. Select 5. COLOUR with the MENU ▼/▲ key. 4. Set the initial setting value for PAL COLOUR with the MENU - or + key. 5. If the colour is not the best with the initial set value, make fine adjustment until you get the best colour.
			SECAM COLOUR	<ol style="list-style-type: none"> 1. Receive a SECAM broadcast. 2. Make fine adjustment of SECAM COLOUR as previously.
			NTSC 3.58 COLOUR	<ol style="list-style-type: none"> 1. Receive a NTSC 3.58MHz broadcast. 2. Make similar fine adjustment of NTSC 3.58 COLOUR as previously.
			NTSC 4.43 COLOUR	When NTSC 3.58 adjustment completed, NTSC 4.43 will be automatically set at the respective values.

Item	Measuring instrument	Test point	Adjustment part	Description
Adjustment of SUB COLOUR II	Signal generator Oscilloscope Remote control unit	TP-47R/G TP-E (↔) [CRT SOCKET PWB]	5. COLOUR	[Method of adjustment using measuring instrument]
			PAL COLOUR	<ol style="list-style-type: none"> 1. Input a PAL full field colour bar signal (75% white). 2. Select 2. V/C from SERVICE MENU. 3. Select 5. COLOUR with the MENU ▼/▲ key. 4. Set the initial setting value of PAL COLOUR with the MENU - or + key. 5. Connect the oscilloscope between TP-47R/G and TP-E (↔). 6. Adjust PAL COLOUR to bring the value of (A) in the illustration to +10V(W-G). (Voltage value between (W) and (G))
			SECAM COLOUR	<ol style="list-style-type: none"> 1. Input a SECAM full field colour bar signal (75% white). 2. Set the initial setting value of SECAM COLOUR with the MENU - or + key. 3. Adjust SECAM COLOUR to bring the value of (A) in the illustration to +8V(W-G). (Voltage value between (W) and (G))
			NTSC 3.58 COLOUR	<ol style="list-style-type: none"> 1. Input a NTSC 3.58 full field colour bar signal (75% white). 2. Set the initial setting value of NTSC 3.58 COLOUR with the MENU - or + key. 3. Adjust NTSC 3.58 COLOUR to bring the value of (A) in the illustration to +5V(W-G). (Voltage value between (W) and (G))
NTSC 4.43 COLOUR	When NTSC 3.58 is set, NTSC 4.43 will be automatically set at the respective values.			

Item	Measuring instrument	Test point	Adjustment part	Description
Adjustment of TINT I	Signal generator Remote control unit		6. TINT	[Method of adjustment without measuring instrument]
			NTSC 3.58 TINT	<ol style="list-style-type: none"> 1. Input a NTSC 3.58 full field colour bar signal (75% white). 2. Select 2. V/C from SERVICE MENU. 3. Select 6. TINT with the MENU ▼/▲ key. 4. Set the initial setting value of NTSC 3.58 with the MENU - or + key. 5. If you cannot get the best tint with the initial setting value, make fine adjustment until you get the best tint.
NTSC 4.43 TINT	When NTSC 3.58 is set, NTSC 4.43 will be automatically set at the respective values.			
Adjustment of TINT II	Signal generator Oscilloscope Remote control unit	TP-47R/G TP-E (↗) [CRT SOCKET PWB]	6. TINT	[Method of adjustment using measuring instrument]
			NTSC 3.58 TINT	<ol style="list-style-type: none"> 1. Input a NTSC 3.58 full field colour bar signal (75% white). 2. Select 2. V/C from SERVICE MENU. 3. Select 6. TINT with the MENU ▼/▲ key. 4. Set the initial setting value of NTSC 3.58 with the MENU - or + key. 5. Connect the oscilloscope between TP-47R/G and TP-E. (↗). 6. Adjust NTSC 3.58 TINT to bring the value of (B) in the illustration +4V(W- Cy). (Voltage value between (W) and (Cy))
NTSC 4.43 TINT	When NTSC 3.58 is set, NTSC 4.43 will be automatically set at the respective values.			

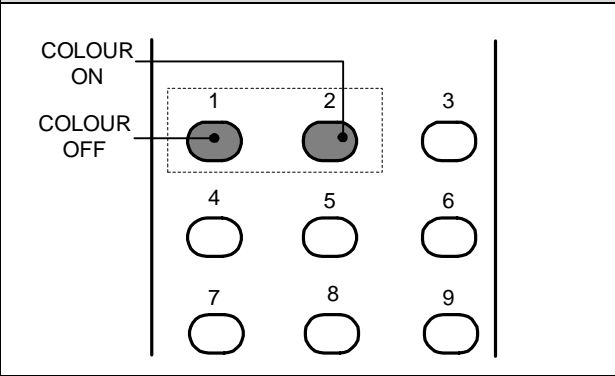
Item	Measuring instrument	Test point	Adjustment part	Description
Adjustment of SECAM BLACK OFFSET	Remote control unit Signal generator		7.SECAM BL ADJUST	<p>[Method of adjustment using measuring instrument]</p> <ol style="list-style-type: none"> 1. Input a SECAM full field colour bar signal. 2. Select 2. V/C from SERVICE MENU. 3. Select 7. SECAM BL ADJUST with ▼/▲MENU key. 4. Set the initial setting value with the – or + MENU key. 5. Switch the ①key (colour OFF) and ②key (colour ON) on the remote control and make sure that there is no colour on the black and white screen. 6. If the black and white screen is not best with the initial setting value, make fine adjustment until you get the best black and white screen. 7. While watching the screen, adjust the value to be the same colour between ON & OFF by Ten key on the remote control unit. 8. Press the DISPLAY key twice to return to the normal screen.
<div style="border: 1px solid black; padding: 5px; margin-bottom: 10px;"> <p style="text-align: center; background-color: #cccccc; margin: 0;">KEY ASSIGNMENT OF REMOTE CONTROL UNIT</p>  </div>				

DEFLECTION CIRCUIT ADJUSTMENT

- There are 2 modes of adjustment (setting value) ----- ① 50Hz mode and ② 60Hz mode ----- depending upon the kind of signals (vertical frequency 50Hz / 60Hz).
- When adjusted in mode ① , mode ② will be automatically set.

The setting (adjustment) using the REMOTE CONTROL UNIT is made on the basis of the initial setting values.
The setting values which adjust the screen to the optimum condition can be different from the initial setting values.

Item	Measuring instrument	Test point	Adjustment part	Description
<p>Adjustment of V.HEIGHT & V.POSITION</p>	<p>Signal generator Remote control unit</p>		<p>1. VER. POSITION 3. VER. HEIGHT</p>	<ol style="list-style-type: none"> 1. Input a circle pattern signal. 2. Select 3. DEF. from SERVICE MENU. 3. Select 1. VER. POSITION with the MENU $\blacktriangledown/\blacktriangle$ key. 4. Set the initial setting value 1. VER. POSITION with the MENU - / + key. 5. Adjust V and V' to be equal with the MENU - / + key as shown in Fig.2. 6. Input a cross-hatch signal. 7. Select 3. V. HEIGHT with the MENU $\blacktriangledown/\blacktriangle$ key. 8. Set the initial setting value 3. V. HEIGHT with the MENU - / + key. 9. As shown in Fig.1, adjust VER. HEIGHT and make the vertical screen size 92% of the picture size with the MENU - / + keys of remote control unit.
<p>Adjustment of HOR. POSITION</p>	<p>Signal generator Remote</p>		<p>2.HOR. POSITION</p>	<ol style="list-style-type: none"> 10. Input a circle pattern signal. 11. Select 2. HOR POSITION with the MENU $\blacktriangledown/\blacktriangle$ key. 12. Set the initial setting value of 2. HOR. POSITION with the MENU - / + key. 13. Adjust 2. HOR. POSITION to make H=H' as shown in Fig.2 with the MENU - / + key.

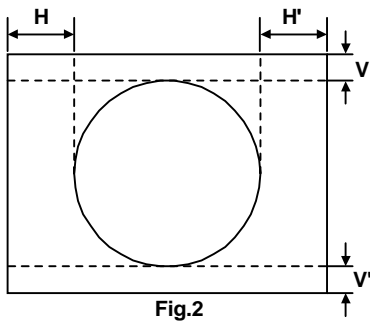
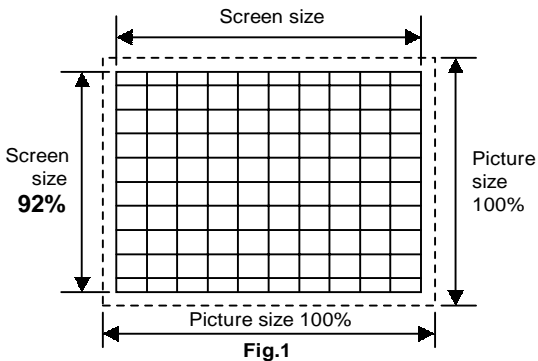
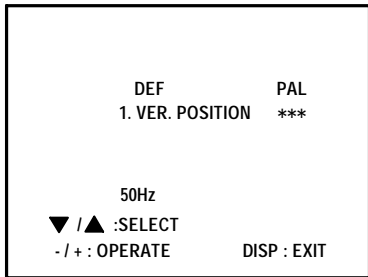

Item	Measuring instrument	Test point	Adjustment part	Description
Adjustment of VER. LIN. & VER. SCURVE	Signal generator Remote control unit		4. VER. LIN. 5. VER. SCURVE	<p>● When the vertical linearity has been deteriorated remarkably, perform the following steps.</p> <p>14. Input a cross-hatch signal. 15. Select 4. VER. LIN. with the MENU ▼/▲ key. 16. Set the initial setting value of 4. VER LIN. with the MENU - / + key. 17. Select 5. VER. SCURVE with the MENU ▼/▲ key. 18. Set the initial setting value of 5. VER. SCURVE with the MENU - / + key. 19. Adjust 4. VER. LIN. and 5. VER. SCURVE so that the spaces of each line as shown in Fig.3 on TOP, CENTER and BOTTOM become uniform.</p> <p>Make sure that the adjustment is properly done on the screen of 60Hz mode.</p> <p>[NOTE]</p> <ul style="list-style-type: none"> ● Adjust to make both 50Hz & 60Hz are the same v. size and fine straight line. ● When adjust again, adjust 50Hz mode first. ● When adjust in 60Hz mode, only 60Hz mode is adjust.

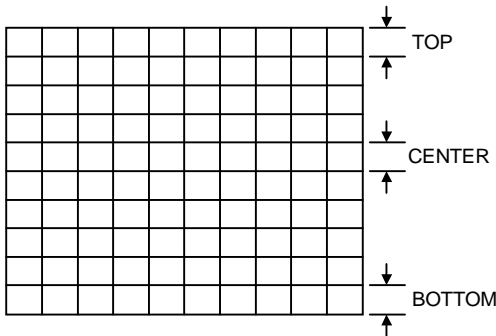

Fig.3

VSM PRESET SETTING

Item	Measuring instrument	Test point	Adjustment part	Description
Setting of VSM PRESET	Remote control unit		TINT COLOUR BRIGHT CONT. SHARP	<p>1. Select 4. VSM PRESET from the SERVICE MENU. 2. Select BRIGHT with the PICTURE MODE key. 3. Adjust the MENU ▼/▲ and MENU - / + key to bring the set values of TINT ~ SHARP to the values shown in the below table. 4. Respectively select the VSM PRESET mode for SOFT and STANDARD, and make similar adjustment as in 3 above.</p>

● VSM PRESET

VSM Setting Item	BRIGHT	STANDARD	SOFT
TINT	+15	←	←
COLOUR	+15	←	←
BRIGHT	+15	←	←
CONT	+30	+15	+8
SHARP	+15	←	+12

PURITY / CONVERGENCE ADJUSTMENT

PURITY ADJUSTMENT

1. Demagnetize CRT with the demagnetizer.
2. Loosen the retainer screw of the deflection yoke.
3. Remove the wedges.
4. Input a green raster signal from the signal generator, and turn the screen to green raster.
5. Move the deflection yoke backward.
6. Bring the long lug of the purity magnets on the short lug and position them horizontally. (Fig.2)
7. Adjust the gap between two lugs so that the GREEN RASTER will come into the center of the screen. (Fig.3)
8. Move the deflection yoke forward, and fix the position of the deflection yoke so that the whole screen will become green.
9. Insert the wedge to the top side of the deflection yoke so that it will not move.
10. Input a crosshatch signal.
11. Verify that the screen is horizontal.
12. Input red and blue raster signals, and make sure that purity is properly adjusted.

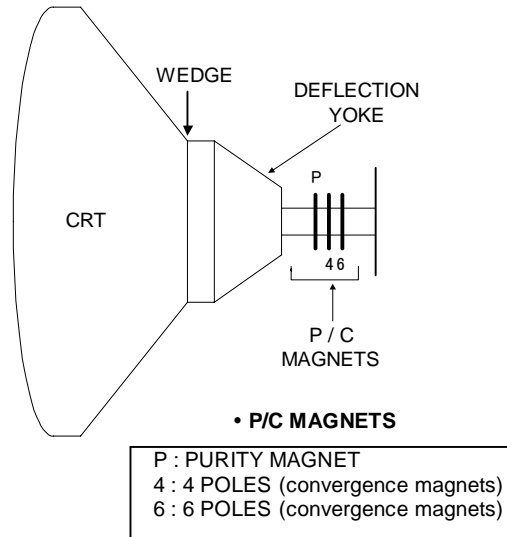

Fig.1

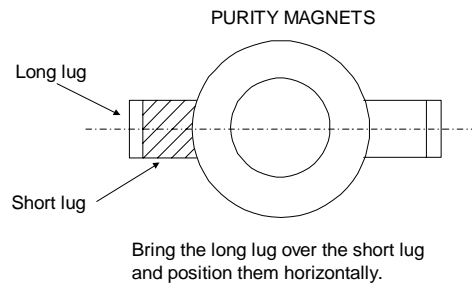

Fig.2

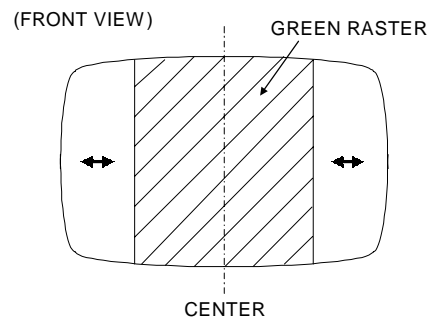

Fig.3

STATIC CONVERGENCE ADJUSTMENT

1. Input a crosshatch signal.
2. Using 4-pole convergence magnets, overlap the red and blue lines in the center of the screen (Fig.1) and turn them to magenta (red/blue).
3. Using 6-pole convergence magnets, overlap the magenta (red/blue) and green lines in the center of the screen and turn them to white.
4. Repeat 2 and 3 above, and make best convergence.

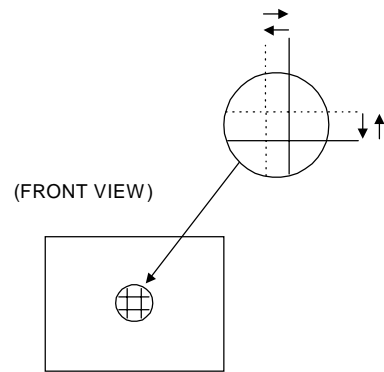

Fig.1

DYNAMIC CONVERGENCE ADJUSTMENT

1. Move the deflection yoke up and down and overlap the lines in the periphery. (Fig. 2)
2. Move the deflection yoke left to right and overlap the lines in the periphery. (Fig. 3)
3. Repeat 1 and 2 above, and make best convergence.

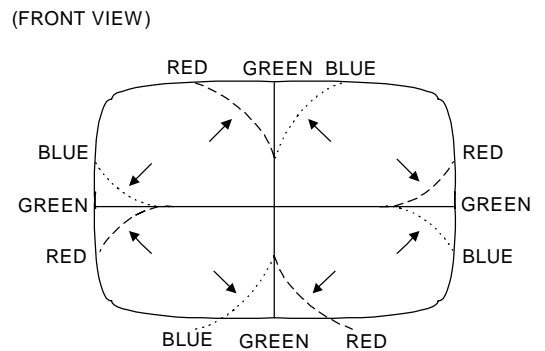

Fig.2

- After adjustment, fix the wedge at the original position. Fasten the retainer screw of the deflection yoke. Fix the 6 magnets with glue.

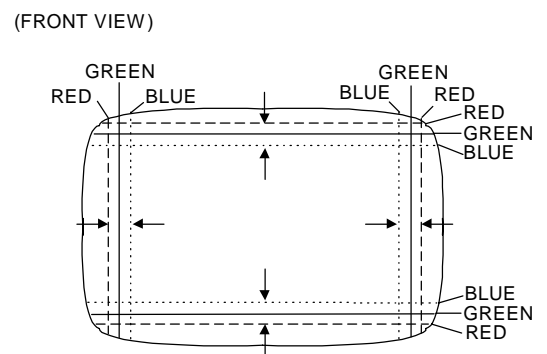

Fig.3

REPLACEMENT OF CHIP COMPONENT

■ CAUTIONS

1. Avoid heating for more than 3 seconds.
2. Do not rub the electrodes and the resist parts of the pattern.
3. When removing a chip part, melt the solder adequately.
4. Do not reuse a chip part after removing it.

■ SOLDERING IRON

1. Use a high insulation soldering iron with a thin pointed end of it.
2. A 30w soldering iron is recommended for easily removing parts.

■ REPLACEMENT STEPS

1. How to remove Chip parts

◆ Resistors, capacitors, etc.

- (1) As shown in the figure, push the part with tweezers and alternately melt the solder at each end.

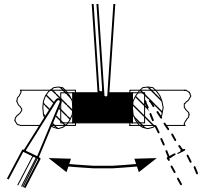

- (2) Shift with tweezers and remove the chip part.

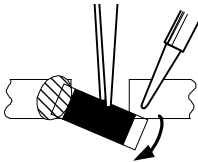

◆ Transistors, diodes, variable resistors, etc.

- (1) Apply extra solder to each lead.

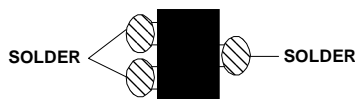

- (2) As shown in the figure, push the part with tweezers and alternately melt the solder at each lead. Shift and remove the chip part.

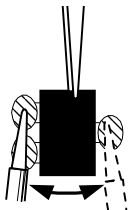

Note : After removing the part, remove remaining solder from the pattern.

2. How to install Chip parts

◆ Resistors, capacitors, etc.

- (1) Apply solder to the pattern as indicated in the figure.

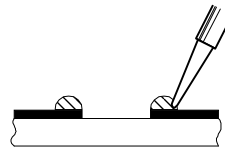

- (2) Grasp the chip part with tweezers and place it on the solder. Then heat and melt the solder at both ends of the chip part.

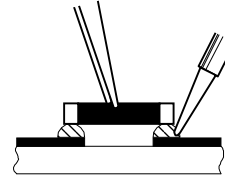

◆ Transistors, diodes, variable resistors, etc.

- (1) Apply solder to the pattern as indicated in the figure.
- (2) Grasp the chip part with tweezers and place it on the solder.
- (3) First solder lead **A** as indicated in the figure.

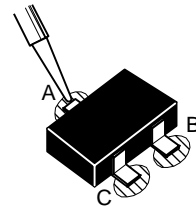

- (4) Then solder leads **B** and **C**.

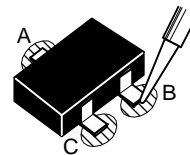

JVC

VICTOR COMPANY OF JAPAN, LIMITED

HOME AV NETWORK BUSINESS UNIT 12, 3-chome, Moriya-cho, Kanagawa-ku, Yokohama, Kanagawa-prefecture, 221-8528, Japan

AV20N10-H #4
AV20NTG2-H #4
AV20NTG2A-H #4



VP 0111
DP7058